

Engineered
for **Easy**



endura[®] **XL**
Grease Interceptor

JUNE 1, 2017

SUPERSEDES C40-0216 (FEBRUARY 1, 2016)

Our website pricing is the current list price and may vary from our printed price list.
Please visit our website for up-to-date information.

Visit us on the web for installation guidelines and operating instructions:

www.endurainterceptor.com 1-800-461-5300

ENDURA® XL GREASE INTERCEPTOR

PRICE LIST C40-0617 JUNE 1, 2017

TERMS AND CONDITIONS OF SALE

TERMS

Cash discount 2% 35 days, net 45. The cash discount is allowed on merchandise only. Prices are subject to change and each order will be priced on the basis of prices in effect at the time of order. All orders are subject to approval of our office in Ontario, Canada. Possession of this price list does not necessarily constitute an offer by the Company to sell to the holder on the basis of the terms described herein.

OVERDUE INVOICES

Interest charged at a rate of 1.5% per month on all overdue invoices.

FREIGHT

\$5000.00 net for prepaid freight. Can be combined with PL39 product to make freight. All shipments are F.O.B. seller's factory or authorized warehouse. Prepaid orders will be shipped via the most economical route of our choice. If the Customer selects a route with a higher rate, the difference will be charged to the Customer.

WEBSITE

Our website pricing is the current list price and may vary from our printed price list. Please visit www.canplasplumbing.com for up-to-date information. Prices and product availability are subject to change without notice. While we try to ensure accuracy, we reserve the right to correct any errors in pricing or descriptions, and to cancel or refuse to accept any order based on an incorrect price or description. Such corrections may be made even after an order is accepted.

SHIPPING RESPONSIBILITY

Canplas' responsibility ceases when the carrier signs for the shipment in good order. We cannot be responsible for loss or damage to goods in transit, or delays or carriers in delivering shipments or for damages resulting from such delays as those caused by fire, explosion, act of God, strike or other difference with workmen, shortage of material or labor, delays in transportation, government restrictions, war, riot, civil commotion or cause beyond our control. Where shortage or damage is apparent, details should be noted by the carrier on the freight bill at the time of delivery. In case of concealed damage, carrier should be called at once to inspect the damaged shipment. Do not return damaged goods.

RETURNED GOODS

A Returned Goods Authorization Form issued by Canplas must accompany goods which are returned. We reserve the right to refuse the return of any item that is not a regular stock item with Canplas. On items that are acceptable for credit, a restocking charge of twenty-five percent (25%) will be assessed against the credit to cover our handling, and/or inspecting or repackaging. Freight on returned goods will be the responsibility of the customer unless the reason for the return is due to defective goods. All goods returned must be in a saleable condition.

OTHER

In addition to sizes listed in this price list, other sizes may be available upon request. The product names used in this price list are for identification purposes only. All trademarks and registered trademarks are the property of their respective owners. Images used are for representation only and actual product may vary from that depicted.



Correct sizing is critical to the function of your interceptor. Find our GI sizing calculator online at: EnduraGICalculator.com

TABLE OF CONTENTS	Page
Endura XL Grease Interceptors	3
Components & Accessories	4

CAUTION

- Installing threaded fittings

When installing threaded fittings, best practice requires that a suitable sealing medium, for example PTFE tape or non oil-based plumbers putty is used, to both seal the joint and ensure a positive and correct fit. Do not over tighten.

ENDURA® XL GREASE INTERCEPTOR

PRICE LIST C40-0617 JUNE 1, 2017

Building on a *field proven approach* to grease management

Endura XL is the latest addition to the Canplas Grease Management line, offering the highest fats, oil and grease separation efficiency in a compact, yet high capacity footprint. Using the latest materials technology and hydromechanical design, Endura XL Interceptors are designed from the ground up to offer convenience and durability, backed by National performance standards.

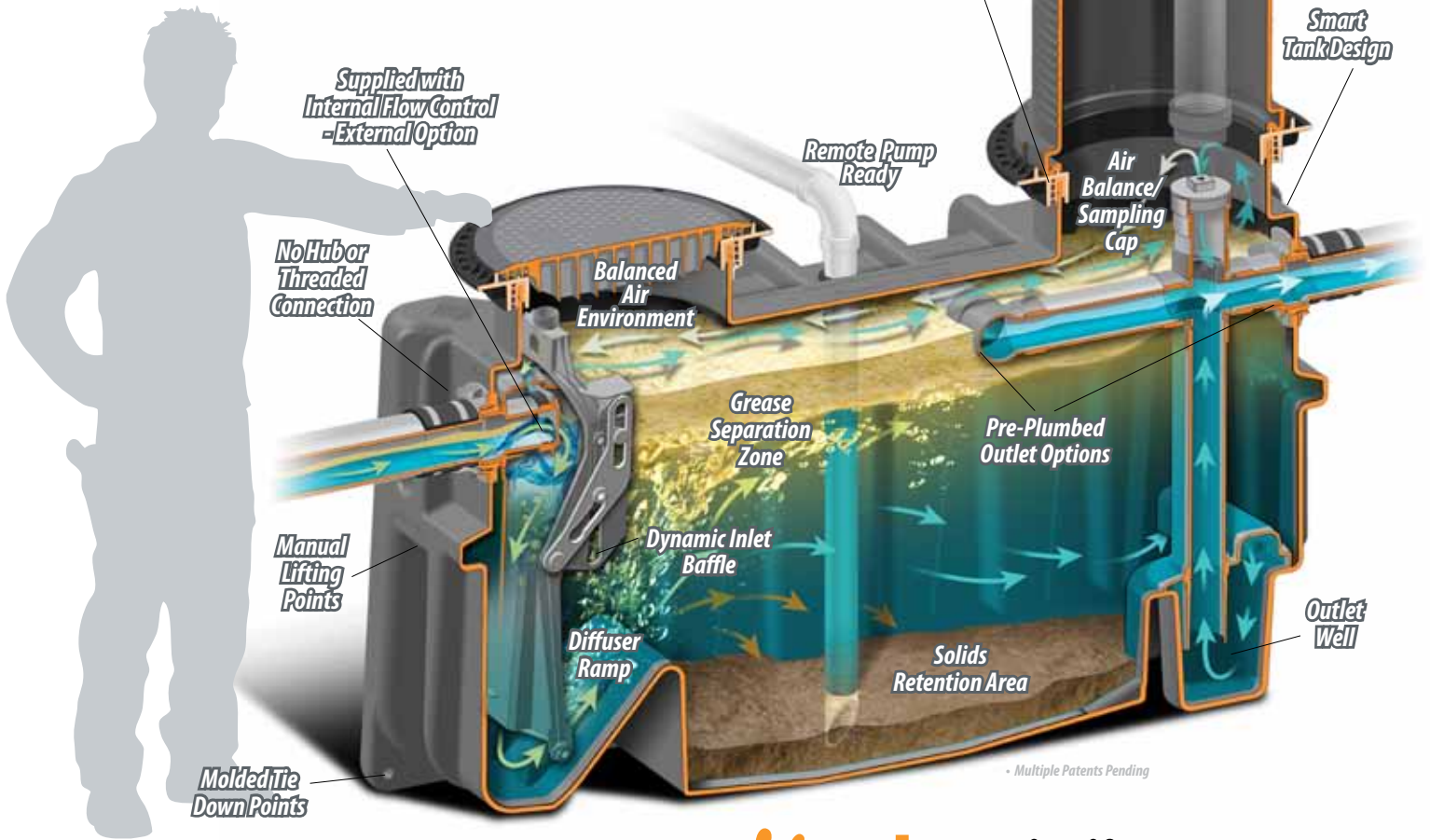

endura[®] XL Grease Interceptor

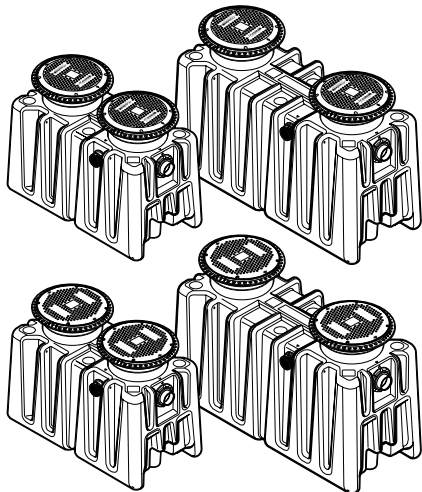

Size G.P.M./Lbs.	Part Number	Connection Size	Flow Rate	Actual Grease Capacity (ASME 112.14.3)	Cover Load Rating	List Price
WITH TRAFFIC RATED COVERS - CSA B481.0 'S' RATED						
75/150	4075A04	4"	75 g.p.m. (4.73L/sec.)	559 lbs. (253 kg)	S	4145.88
100/200	40100A04	4"	100 g.p.m. (6.31L/sec.)	1058 lbs. (480 kg)	S	6401.73
WITH PEDESTRIAN / LIGHT TRAFFIC COVERS - CSA B481.0 'M' RATED						
75/150	4075A04M	4"	75 g.p.m. (4.73L/sec.)	559 lbs. (253 kg)	M	3844.45
100/200	40100A04M	4"	100 g.p.m. (6.31L/sec.)	1058 lbs. (480 kg)	M	6019.57

ENDURA® XL GREASE INTERCEPTOR

PRICE LIST C40-0617 JUNE 1, 2017

Components & Accessories

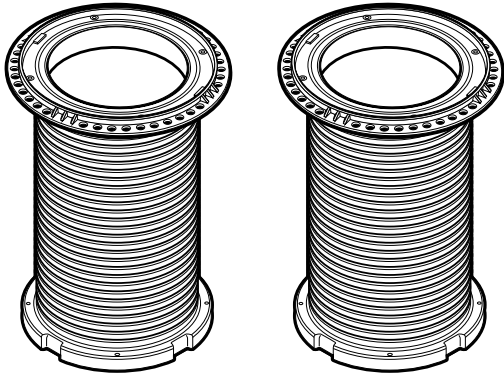

Endura® XL Extension Riser - Pair (Includes 2 x frame and all installation hardware)			
Part Number	Size	Shipping Weight	List Price
40100AX35	18" Dia (Nom) 35" Cut-to-length	36.34 kg.	1623.99

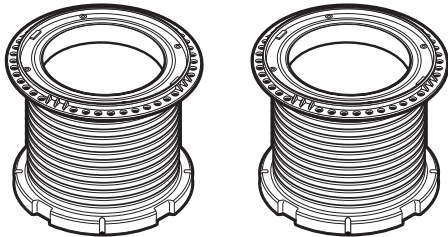

Endura® XL Extension Riser - Pair (Includes 2 x frame and all installation hardware)			
Part Number	Size	Shipping Weight	List Price
40100AX18	18" Dia (Nom) 18" Cut-to-length	25.54 kg.	1391.20

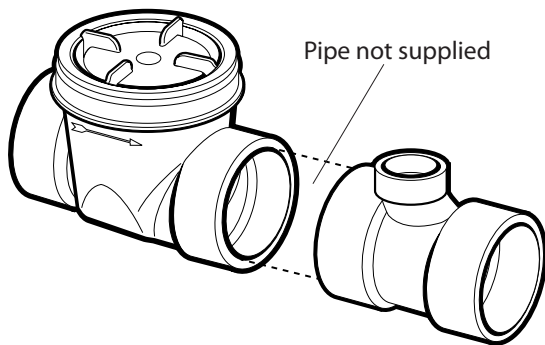

Endura® XL Flow Control			
Part Number	Flow Rate	Connection Size	List Price
4044275A	75 g.p.m. (4.73L/sec.)	4"	160.74
40442100A	100 g.p.m. (6.31L/sec.)	4"	160.74

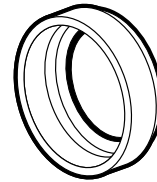

Endura® XL Connector Gasket		
Part Number	Size	List Price
40100-23	4" SDR	53.21

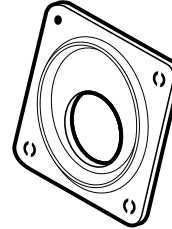

Endura® XL Internal Flow Control Plate		
Part Number	Flow Rate	List Price
4075-21	75 g.p.m. (4.73L/sec.)	13.30
40100-21	100 g.p.m. (6.31L/sec.)	13.30

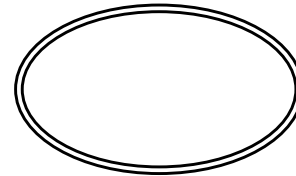

Endura® XL Riser Seal / Endura XL 'M' Cover Seal		
Part Number	Size	List Price
40100X35-2	56" (Nom)	53.21

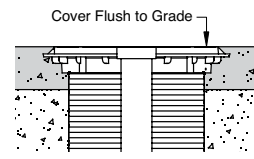
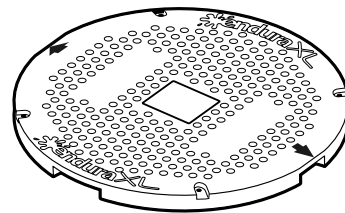

Endura® XL Replacement Cover Pedestrian/Light Traffic Rated CSA B481.0 Class 'M'			
Part Number	Size	Load Capacity	List Price
40100ARCM	22" Nom	(2000lbs)	487.47

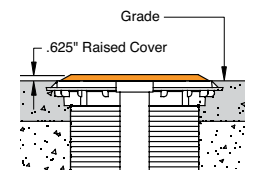
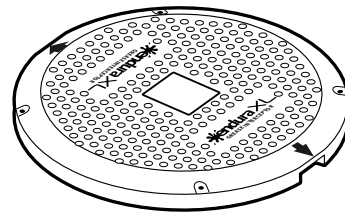

Endura® XL Replacement Cover Traffic Rated CSA B481.0 Class 'S'			
Part Number	Size	Load Capacity	List Price
40100ARCS	22" Nom	(10000lbs)	722.76

ENDURA® XL GREASE INTERCEPTOR

PRICE LIST C40-0617 JUNE 1, 2017



Introducing NEW Endura XL Pedestrian/ Light Traffic Rated Models CSA B481.0 Class 'M'



When located inside the facility being served or any non-vehicle traffic area, EnduraXL is now available with a 'M' Rated Access Covers. Like our 'S' rated cover, the new 'M' rated version is tested & approved to the CSA B481.0 requirement – Class M, offering a service load of 2000lbs at both elevated and sub-zero temperatures. For pedestrian/light traffic applications the cover is flush with the surrounding floor or grade finish, and easily identified by its mid grey colour.

- Flush to floor/grade finish when installed
- Compatible with all existing XL interceptors in service
- Odor-tight operation
- CSA B481.0 – Class M Rated (2000lbs) – 2x Safety Factor
- Suffix regular part number with 'M'

Size G.P.M./ Lbs.	Part Number	Connection Size	Flow Rate	Actual Grease Capacity (ASME 112.14.3)	Cover Load Rating	List Price
WITH PEDESTRIAN / LIGHT TRAFFIC COVERS - CSA B481.0 'M' RATED						
75/150	4075A04M	4"	75 g.p.m. (4.73L/sec.)	559 lbs. (253 kg)	M	See Page 3
100/200	40100A04M	4"	100 g.p.m. (6.31L/sec.)	1058 lbs. (480 kg)	M	See Page 3

endura XL
Grease Interceptor

ENDURA® XL GREASE INTERCEPTOR

PRICE LIST C40-0617 JUNE 1, 2017

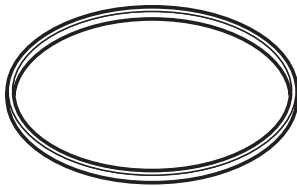

Endura® XL Cover Seal		
Part Number	Size	List Price
40100-4	56" (Nom)	44.34

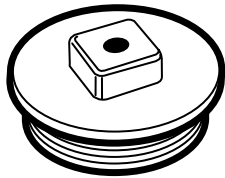

Endura® XL Sampling / Air Balance Cap		
Part Number	Size	List Price
40100-33	4"	26.60

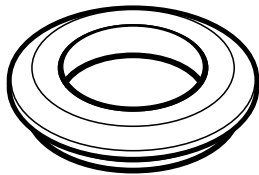

Endura® XL Tank Penetration Seal - Remote Pump		
Part Number	Size	List Price
40100TPS3	3" (Sch 40)	39.91

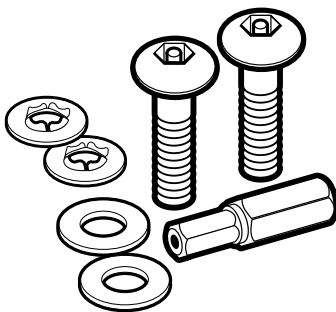

Endura® XL Security Fastener Kit		
Part Number	Included	List Price
40100ARSB	5/16" x 1-1/2" Tamper-Resist Cover Fastener & Drive Bit x 2	70.39

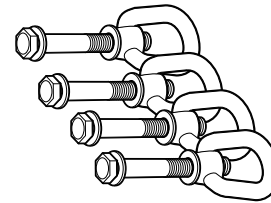

Endura® XL Lifting Hardware Kit		
Part Number	Included	List Price
40100ALHK	Eye Nut, Bolt, Washer x 2, Set of 4 Reusable	304.84

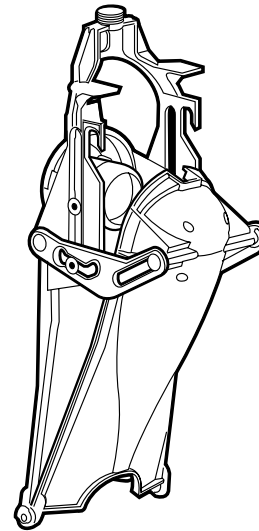

Endura® XL Dynamic Inlet Baffle Replacement (Includes Connector & Seal)		
Part Number	Size	List Price
4075ARDB	75 g.p.m.	526.55
40100ARDB	100 g.p.m.	526.55

Visit our website for more information

- Grease Interceptor Sizing Calculator
- Specification Sheets
- E-Newsletter
- Price Lists

www.endurainterceptor.com

ENDURA® XL GREASE INTERCEPTOR

PRICE LIST C40-0617 JUNE 1, 2017

PART#	WEIGHT (Kg.)	CARTON BARCODE	PG. #	PART#	WEIGHT (Kg.)	CARTON BARCODE	PG. #	PART#	WEIGHT (Kg.)	CARTON BARCODE	PG. #
4044275A	2.248	10662671067705	4								
40442100A	2.248	10662671067712	4								
40100-21	0.107	10662671067576	4								
40100-23	0.092	10662671067415	4								
40100-33	0.198	10662671067606	6								
40100-4	0.283	00662671067104	6								
40100TPS3	0.07	10662671067767	6								
40100A04	134.207	20662671066248	3								
40100ALHK	1.844	10662671068351	6								
40100ARCS	4.665	10662671070606	4								
40100ARDB	5.566	10662671068009	6								
40100ARSB	0.041	10662671068412	6								
40100AX18	25.54	10662671069044	4								
40100AX35	36.34	10662671066296	4								
40100X35-2	0.07	00662671066992	4								
4075-21	0.107	10662671067583	4								
4075A04	110.856	20662671066279	3								
4075ARDB	5.566	10662671068016	6								
4075A04M	100.644	20662671070757	3								
40100A04M	123.995	10662671070736	3								
40100ARCM	4.452	10662671070613	4								

INTERCEPTOR SIZING & SELECTION

Sizing your application is easy at www.endurainterceptor.com. Click on the Endura® Quick Sizing tool at the bottom of the menu listing. Simply enter your sink dimensions and any additional appliances that will discharge through your interceptor. Choose and enter your drain period and the tool does the rest! It's that easy.

CAUTION

The Seller does not recommend the Endura® Grease Interceptor for testing of plumbing systems with compressed air or compressed water. The use of Endura® Interceptors during testing voids our warranty for the products so used. For further information, contact your Canplas representative.

ENDURA® Grease Interceptor Limited Lifetime Warranty Canplas Industries Ltd. ("Canplas") guarantees to the original consumer purchaser ("Original Purchaser") of Endura XL Grease Management Products (hereafter referred to as "Products") that Canplas will replace any such Products that are defective in materials or workmanship, subject to the limitations detailed herein. If replacement is not commercially practical or cannot be made in a timely manner, then Canplas will, at its discretion,

refund the purchase price. This warranty applies only to Products installed in a commercial application. THIS EXPRESS WARRANTY IS IN LIEU OF AND EXCLUDES ALL OTHER WARRANTIES, WHETHER EXPRESSED, IMPLIED OR STATUTORY, INCLUDING IMPLIED WARRANTIES OF MERCHANTABILITY OR FITNESS FOR A PARTICULAR PURPOSE. THIS EXPRESS WARRANTY SPECIFICALLY EXCLUDES INSTALLATION AND/OR REPAIR COSTS, INCLUDING LABOUR.

The Products have a limited warranty from the date of purchase against defects in workmanship and materials. Any Product believed to be defective must be returned to the Canplas manufacturing facility located at 31 Patterson Road, Barrie, Ontario, Canada L4N 3V9 with freight prepaid, or, at Canplas' sole discretion, an on-site inspection may be arranged. Canplas reserves the right to inspect all allegedly defective Products. Any Products found to be defective following examinations will be replaced free of charge

and returned freight prepaid at the absolute discretion of Canplas Industries Ltd. All products returned under this warranty must have proof of purchase information included. Please Note: This warranty is offered by Canplas Industries Ltd. No claim should be placed upon the Installer or Service Company if properly installed and serviced.



All Canplas Endura® Grease Interceptors are tested and certified to Standard PDI-G101 of the Plumbing and Drainage Institute.

ENDURA® XL GREASE INTERCEPTOR



canplas®

Head Office, Manufacturing Location and Customer Service Centre

500 VETERANS DRIVE, BOX 1800
BARRIE, ON L4M 4V3
CANADA

TELEPHONE: (705) 726-3361
FAX: (705) 726-2186
EMAIL: separation-tech@canplas.com

Customer Service Centre and Sales Office

9489 - 200 STREET, UNIT 201
LANGLEY, B.C. V1M 3A7
CANADA

TELEPHONE: (604) 455-0432
FAX: (604) 455-0452

Customer Service Centre and Sales Office

11408-163rd STREET
EDMONTON, AB T5M 3T3
CANADA

TELEPHONE: (780) 451-3206
FAX: (780) 452-0536

www.endurainterceptor.com

1-800-461-5300



an *OAliaxis* company